



Paulmann

### Safety Instructions

1, 2, 3, 4, 5, 6, 7, 8, 11, 12, 15, 16, 17, 18, 19, 20, 21, 22, 24, 26, 33, 34



Info

[www.paulmann.com](http://www.paulmann.com)

Paulmann Licht GmbH  
Quezinger Feld 2  
31832 Springe  
Germany

[www.paulmann.com](http://www.paulmann.com)

Art.-Nr.:  
**500.78**

(+MA 326) PLD 08/17

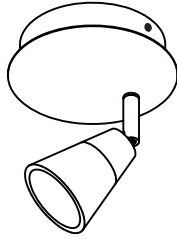

Incl.

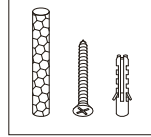

∅ 6mm



**A**

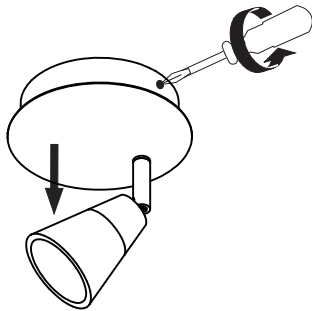

**B**

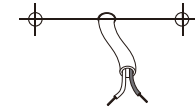
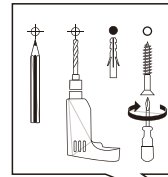

Safety  
Instructions  
Nr. 4, 5, 6, 7



**C**

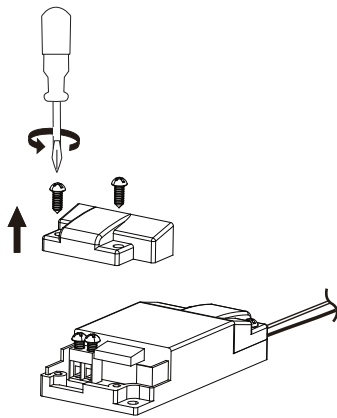

**D**



Safety  
Instructions  
Nr. 4, 5, 6

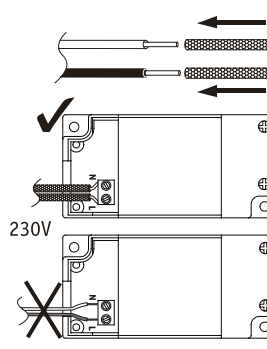
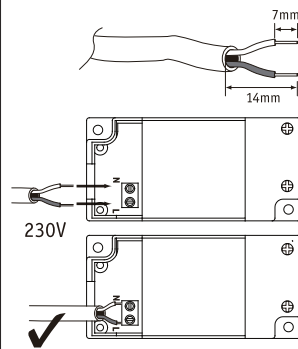

**E**



Safety  
Instructions  
Nr. 4, 5, 6

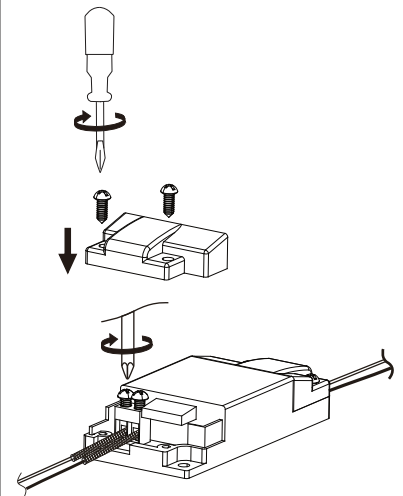

**F**

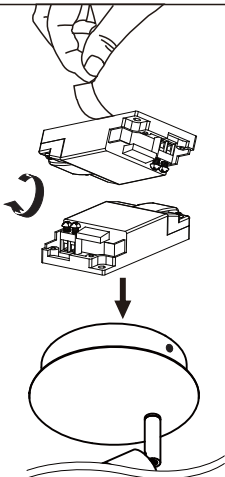

**G**

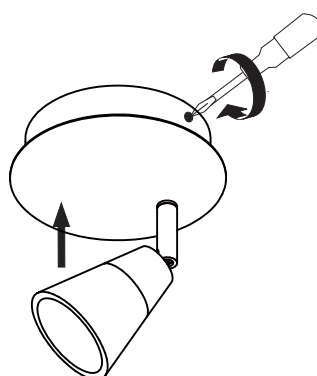

**H**

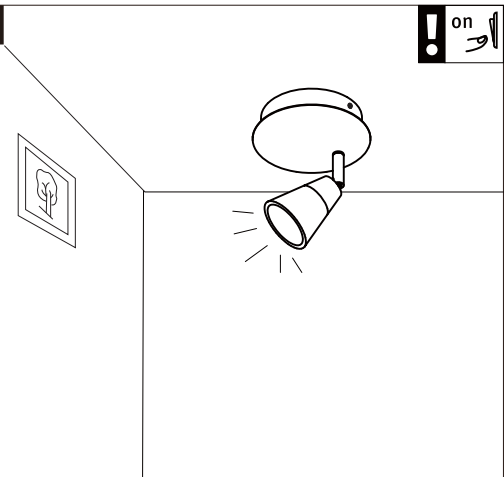

on

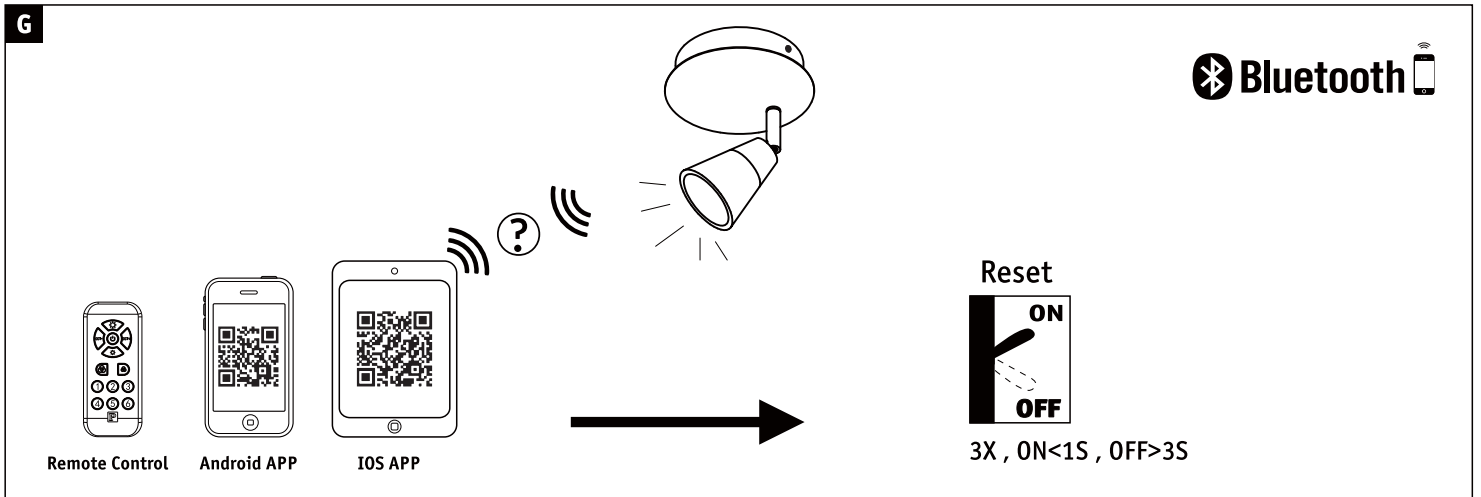
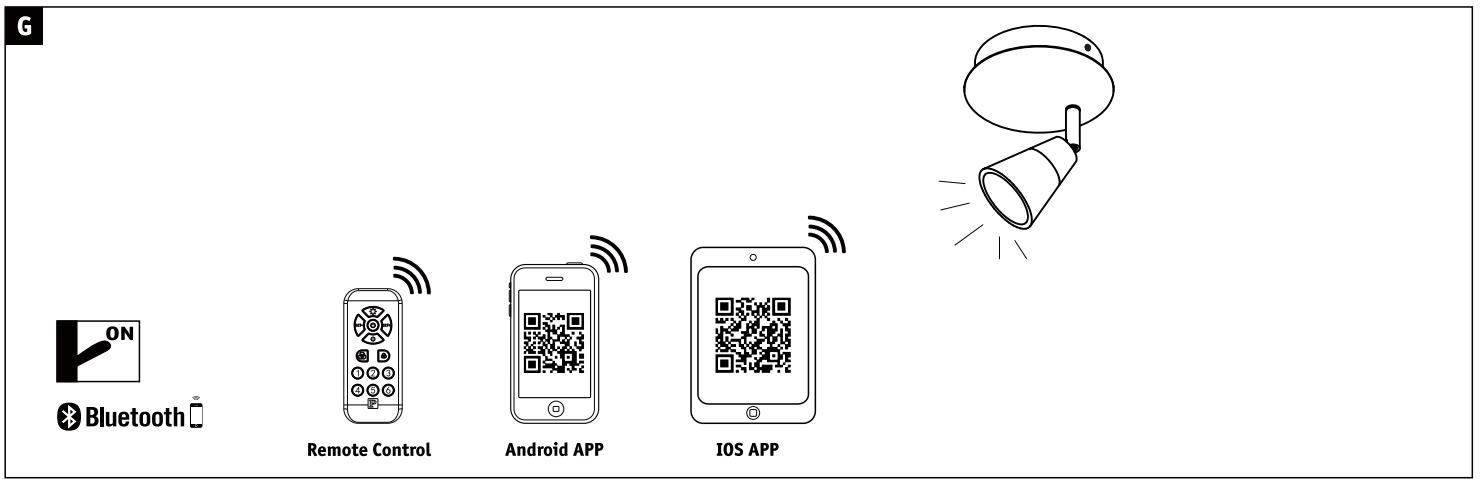

**I**

**Paulmann Home**

IOS APP

Android APP

**Not incl. Smart Device**

- iPad
- iPhone 4S Higher
- Android 4.4 Higher
- Bluetooth 4.0 Higher

Not incl. Remote Control

Paulmann Art.-Nr.500.01

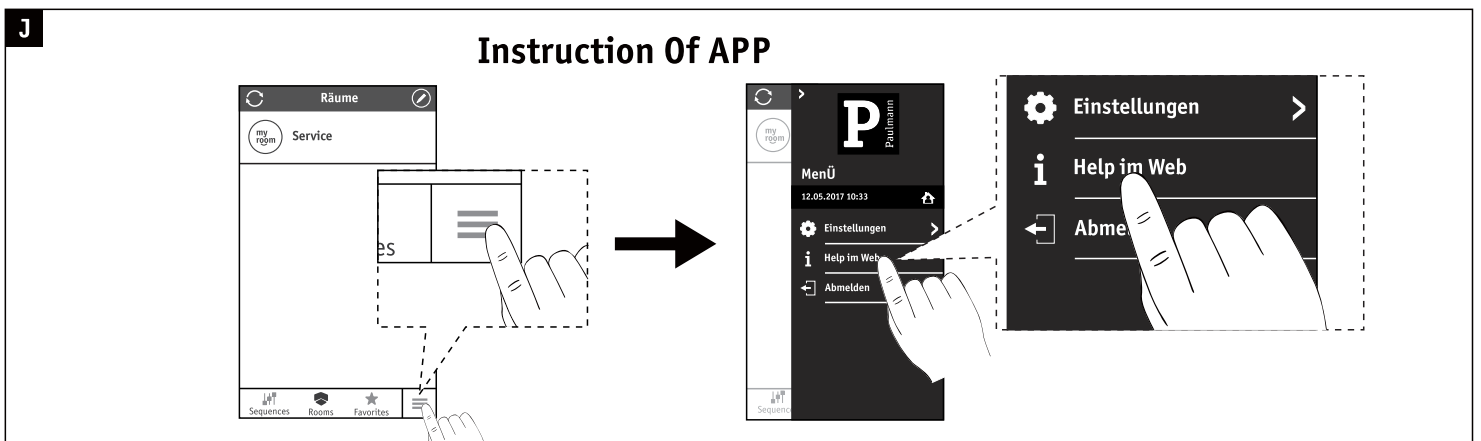

Hiermit erklärt Paulmann Licht, dass der Funkanlagentyp Art.-Nr.:500.78 Richtlinie 2014/53/EU entspricht. Der vollständige Text der EU-Konformitätserklärung ist unter der folgenden Internetadresse verfügbar: [www.paulmann.de](http://www.paulmann.de)